

771

Milliamp Process Clamp Meter

Calibration Manual

LIMITED WARRANTY AND LIMITATION OF LIABILITY

This Fluke product will be free from defects in material and workmanship for 3 years (one year for cable and clamp) from the date of purchase. This warranty does not cover fuses, disposable batteries or damage from accident, neglect, misuse or abnormal conditions of operation or handling. Resellers are not authorized to extend any other warranty on Fluke's behalf. To obtain service during the warranty period, send your defective Meter to the nearest Fluke Authorized Service Center with a description of the problem.

THIS WARRANTY IS YOUR ONLY REMEDY. NO OTHER WARRANTIES, SUCH AS FITNESS FOR A PARTICULAR PURPOSE, ARE EXPRESSED OR IMPLIED. FLUKE IS NOT LIABLE FOR ANY SPECIAL, INDIRECT, INCIDENTAL OR CONSEQUENTIAL DAMAGES OR LOSSES, ARISING FROM ANY CAUSE OR THEORY. Since some states or countries do not allow the exclusion or limitation of an implied warranty or of incidental or consequential damages, this limitation of liability may not apply to you.

Fluke Corporation
P.O. Box 9090
Everett, WA 98206-9090
U.S.A.

Fluke Europe B.V.
P.O. Box 1186
5602 BD Eindhoven
The Netherlands

ООО «Флюк СИАЙЭС»
125167, г. Москва,
Ленинградский проспект дом 37,
корпус 9, подъезд 4, 1 этаж

Table of Contents

Title	Page
Introduction	1
Contacting Fluke	2
Safety Information	2
Symbols	3
Specifications	4
Getting Acquainted with the Meter	5
Maintenance.....	7
Cleaning the Meter	7
Battery Replacement	7
Performance Tests.....	9
Required Equipment	9
Testing the Batteries.....	9
Testing the Display	10
Display Hold Test.....	10
Backlight Test	10
Spotlight LED Test.....	10
Zero Test	10
Accuracy Tests	11
Calibration Adjustment	12
Adjustment Subroutines.....	12
Front Panel Operation for Adjustment	12
Calibration Error Messages	13
Calibration Adjustment Procedure	13
Temperature Adjustment Procedure	14
Low Range Adjustment Procedure	14
High Range Adjustment Procedure	14
Phase Adjustment Procedure	15
User Replaceable Parts	16

771 **Milliamp Process Clamp Meter**

Introduction

Warning

To prevent electric shock or personal injury, do not perform the calibration verification tests or calibration procedures described in this manual unless you are qualified to do so. The information provided in this manual is for the use of qualified personnel only.

This manual provides the complete verification and adjustment procedure for the 771 Milliamp Process Clamp Meter (the Meter or Product).

The Meter allows closed-case calibration using reference sources. It measures the reference signals, calculates the correction factors, and stores them in memory. The instrument should be calibrated after repair, or if it fails a performance test.

The *771 Calibration Manual* provides the following information:

- Precautions and safety information
- Specifications
- Basic maintenance
- Calibration verification procedure
- Replaceable parts and accessories

For complete operating instructions, refer to the *771 Instruction Sheet*.

Contacting Fluke

To contact Fluke, call one of the following telephone numbers:

- Technical Support USA: 1-800-44-FLUKE (1-800-443-5853)
- Calibration/Repair USA: 1-888-99-FLUKE (1-888-993-5853)
- Canada: 1-800-36-FLUKE (1-800-363-5853)
- Europe: +31 402-675-200
- Japan: +81-3-6714-3114
- Singapore: +65-6799-5566
- China: +86-400-921-0835
- Brazil: +55-11-3530-8901
- Anywhere in the world: +1-425-446-5500

Or, visit Fluke's website at www.fluke.com.

To register your product, visit <http://register.fluke.com>.

To view, print, or download the latest manual supplement, visit <http://us.fluke.com/usen/support/manuals>.

Safety Information

A **Warning** identifies conditions and procedures that are dangerous to the user.

A **Caution** identifies conditions and procedures that can cause damage to the Product or the equipment under test.

Warning

To prevent possible electrical shock, fire, or personal injury:

- Carefully read all instructions.
- Do not alter the Product and use only as specified, or the protection supplied by the Product can be compromised.
- Before each use, inspect the Meter and cable for damage. Look for cracks and missing portions of the clamp and cable. Do not use if clamp is damaged.
- Do not use to measure ac current.
- Do not touch voltages >30 V ac rms, 42 V ac peak, or 60 V dc.
- Do not work alone.
- Use the Clamp only on insulated conductors. Use caution around bare conductors or bus bars. To prevent electrical shock, do not touch the conductor.
- Replace the batteries when the low battery indicator shows to prevent incorrect measurements.

- **Comply with local and national safety codes. Use personal protective equipment (approved rubber gloves, face protection, and flame-resistant clothes) to prevent shock and arc blast injury where hazardous live conductors are exposed.**
- **Hold the Product behind the tactile barrier. See Figure 1.**
- **Do not use on non-insulated conductors.**













⚠ Caution

To prevent damage to the Meter, do not open the Meter for cleaning. Do not use solvents to clean it, and do not immerse it in liquid.

Symbols

Table 1 explains the symbols that are used on the Meter or in this manual.

Table 1. Symbols

	Do not apply around, or remove from HAZARDOUS LIVE conductors
	Consult user documentation.
	WARNING. RISK OF DANGER.
	WARNING. HAZARDOUS VOLTAGE. Risk of electric shock.
	On/Off
	Battery
	DC (Direct Current)
	Avoid strong magnetic fields.
	Conforms to European Union directives.
	Conforms to relevant Australian Safety and EMC standards
	Certified by CSA Group to North American safety standards.
	This product complies with the WEEE Directive marking requirements. The affixed label indicates that you must not discard this electrical/electronic product in domestic household waste. Product Category: With reference to the equipment types in the WEEE Directive Annex I, this product is classed as category 9 "Monitoring and Control Instrumentation" product. Do not dispose of this product as unsorted municipal waste.

Specifications

Current Ranges	±20.99 mA	±21.0 mA to ±99.9 mA
Resolution	0.01 mA	0.1 mA
Accuracy		
20.99 mA range	0.2 % reading ±5 digits	
99.9 mA range	1 % reading ±5 digits	
Maximum Reading	±99.9 mA	
Influence of Earth's Field	<0.20 mA	
Battery	2 AA 1.5 V Alkaline, IEC LR6	
Battery Life	40 hours	
Size (H X W X L)	59 mm x 38 mm x 212 mm (2.32 in x 1.49 in x 8.34 in) (with clamp nested)	
Weight	260 g (9.17 oz) (Including battery)	
Operating Temperature	-10 °C to 50 °C (14 °F to 122 °F)	
Storage Temperature	-25 °C to 60 °C (-13 °F to 140 °F)	
Operating Humidity	<90 % @ <30 °C (86 °F) <75 % @ 30 °C to 50 °C (86 °F to 122 °F)	
Operating Altitude	0 m to 2000 m	
Storage Altitude	None	
IP Rating	IP40	
Vibration Requirements	Random 2 g, 5 Hz to 500 Hz	
Temperature Coefficients	0.1x (specified accuracy)/°C (<18 °C or >28 °C)	
AC Noise Rejection	≥5 Hz, the Meter reading is the mean value of the measured current	
Diameter of Measurable Conductor	4.5 mm maximum	
Electrical Compatibility (EMC)		
General	IEC 61010-1: Pollution Degree 2	
International	IEC 61326-1: Portable Electromagnetic Environment; IEC 61326-2-2 CISPR 11: Group 1, Class A	

Group 1: Equipment has intentionally generated and/or uses conductively-coupled radio frequency energy that is necessary for the internal function of the equipment itself.

Class A: Equipment is suitable for use in all establishments other than domestic and those directly connected to a low voltage power supply network that supplies buildings used for domestic purposes. There may be potential difficulties in ensuring electromagnetic compatibility in other environments due to conducted and radiated disturbances.

Caution: This equipment is not intended for use in residential environments and may not provide adequate protection to radio reception in such environments.

Getting Acquainted with the Meter

Figure 1 shows the Meter functions and features.

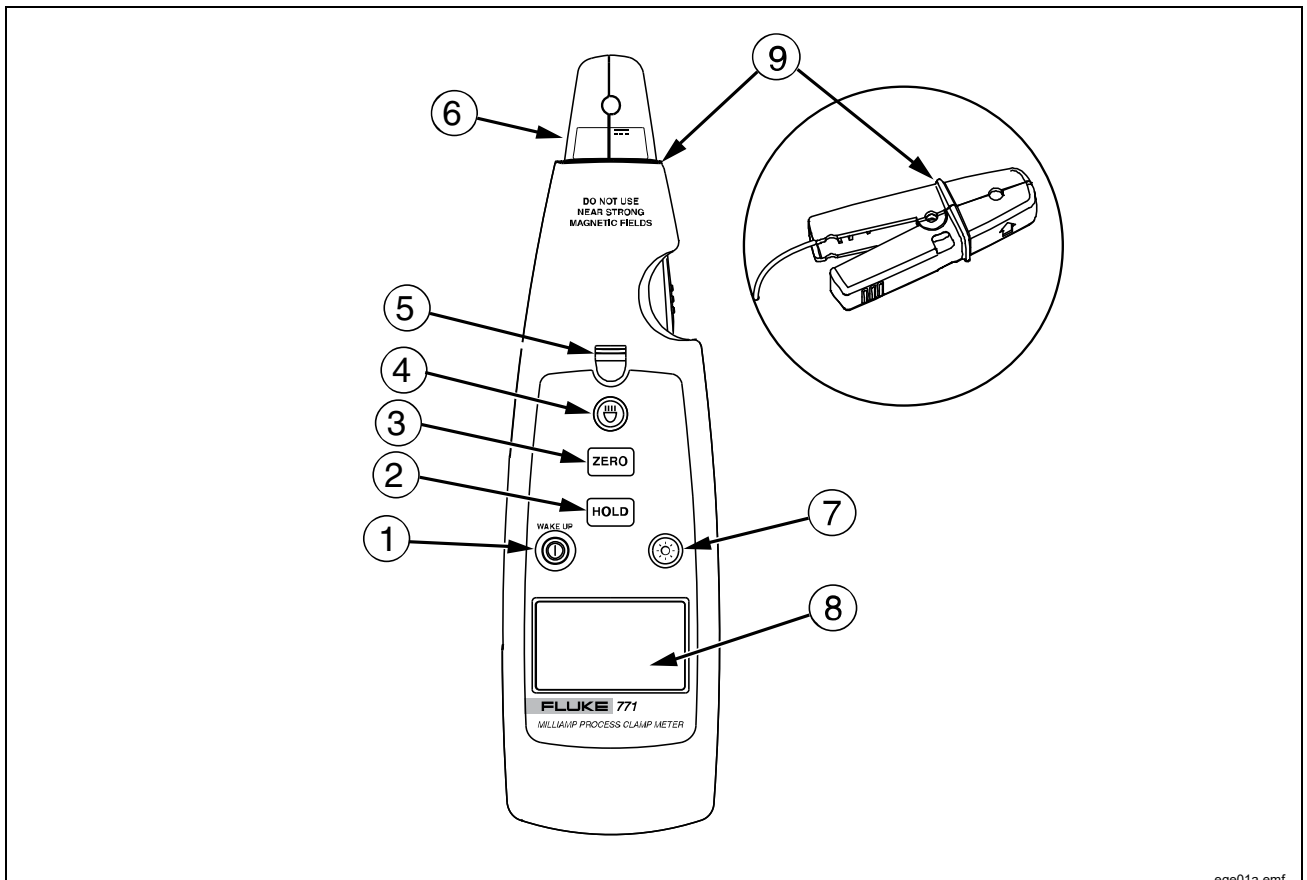

ege01a.emf

Number	Description
①	Turn on and turn off the Meter. When the Meter is in sleep mode, press this button to wake it up.
②	Captures and holds the current reading
③	Removes interference and zeros the display
④	Measurement spotlight LED button
⑤	Measurement spotlight LED
⑥	Detachable clamp
⑦	Turn on and turn off the backlight
⑧	LCD
⑨	Tactile Barrier docked and un-docked

Figure 1. The 771 Milliamp Process Clamp Meter



Static Awareness



Semiconductors and integrated circuits can be damaged by electrostatic discharge during handling. This notice explains how to minimize damage to these components.

1. Understand the problem.
2. Learn the guidelines for proper handling.
3. Use the proper procedures, packaging, and bench techniques.

Follow these practices to minimize damage to static sensitive parts.

⚠️⚠️ Warning

To prevent electric shock or personal injury. De-energize the product and all active circuits before opening a product enclosure, touching or handling any PCBs or components.

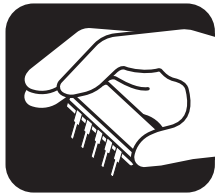

- Minimize handling.
- Handle static-sensitive parts by non-conductive edges.
- Do not slide static-sensitive components over any surface.
- When removing plug-in assemblies, handle only by non-conductive edges.
- Never touch open-edge connectors except at a static-free work station.

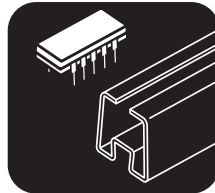

- Keep parts in the original containers until ready for use.
- Use static shielding containers for handling and transport.
- Avoid plastic, vinyl, and Styrofoam® in the work area.



- Handle static-sensitive parts only at a static-free work station.
- Put shorting strips on the edge of the connector to help protect installed static-sensitive parts.
- Use anti-static type solder extraction tools only.
- Use grounded-tip soldering irons only.

Maintenance

Warning

To prevent possible electric shock or personal injury, repairs or servicing not covered in this manual should be performed only by qualified personnel.

Cleaning the Meter

Warning

To prevent electrical shock, remove any input signals before cleaning.

Caution

To prevent damaging the Meter, do not use aromatic hydrocarbons or chlorinated solvents for cleaning. These solutions will react with the plastics used in the Meter.

Clean the instrument case with a damp cloth and mild detergent.

Note

Dirt or debris on the surface of the sensor in the clamp jaw will impact the precision of measurements. For best performance, clean the sensor surfaces with a soft cloth and a solution of Isopropyl alcohol as needed.

Battery Replacement

Warning

To prevent possible electrical shock, fire, or personal injury:

- Replace the batteries when the low battery indicator shows to prevent incorrect measurements.
- Remove the batteries if the Product is not used for an extended period of time, or if stored in temperatures $>50\text{ }^{\circ}\text{C}$. If the batteries are not removed, battery leakage may result.

To replace the batteries, see Figure 2:

1. Turn off the Meter.
2. Use a flat head screwdriver to loosen the battery access door fastener and remove the door from the case bottom.
3. Remove the batteries.
4. Replace the batteries with two new AA batteries.
5. Reattach the battery access door to the case bottom and tighten the fastener.

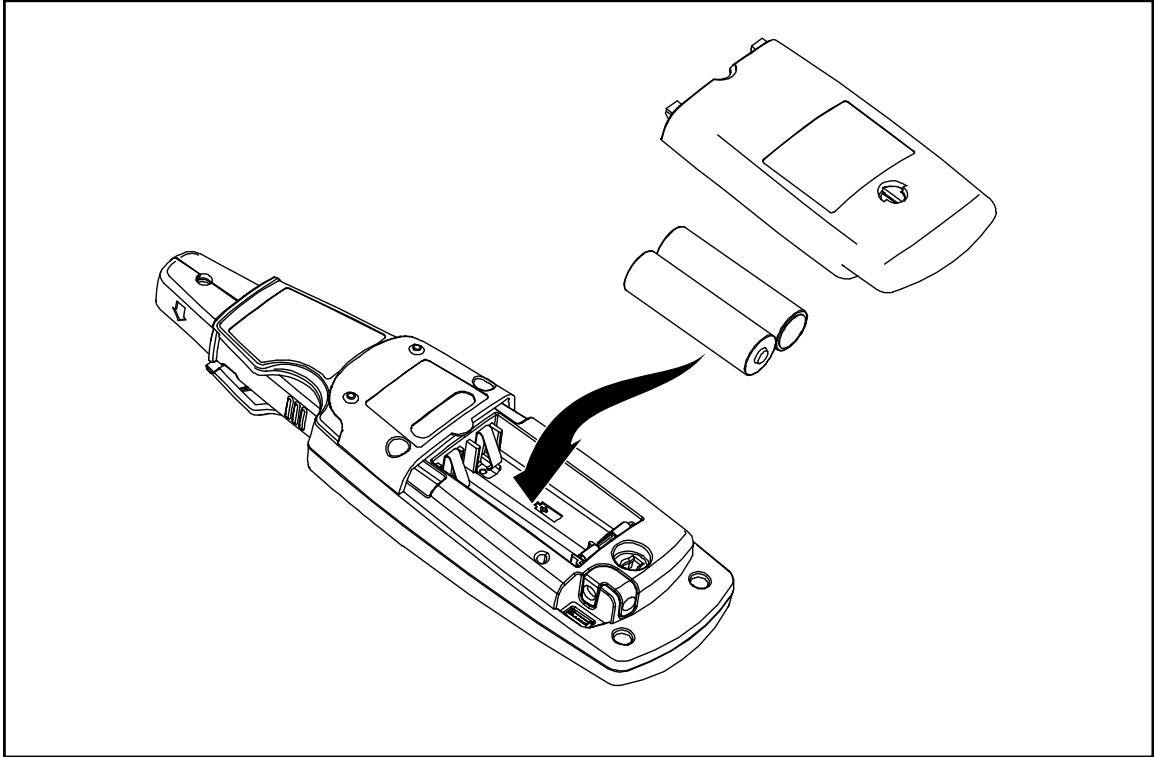

Figure 2. Changing the Batteries

ege02.emf

Performance Tests

⚠⚠ Warning

To prevent electrical shock, personal injury, or fire:

- Do not perform the verification tests or calibration adjustment described in this manual unless you are qualified to do so.
- Repairs or servicing should be performed only by qualified personnel.

The following tests are used to verify the functions of the Meter. If the Meter fails any of the verification tests, repair is necessary. For service, see Contacting Fluke.

Required Equipment

Required equipment for the performance tests is listed in Table 2. If the recommended models are not available, equipment with equivalent specifications may be used.

Table 2. Required Equipment

Equipment	Minimum Required Characteristics	Recommended Model
Calibrator	DC Current Accuracy: Range: 20.99 mA = 0.11 % 99.9 mA = 0.375 %	5520A or equivalent
1 loop insulated copper wire	Insulated 18 gauge, minimum, copper wire, 6-inch diameter	

Testing the Batteries

Prior to performing the following tests, check the batteries with a multimeter and replace as necessary. See *Battery Replacement*.

Testing the Display

1. Press and hold **ZERO** while powering on the Meter.
2. Compare the Meter display to Figure 3.
3. Check all display segments for clarity and contrast.

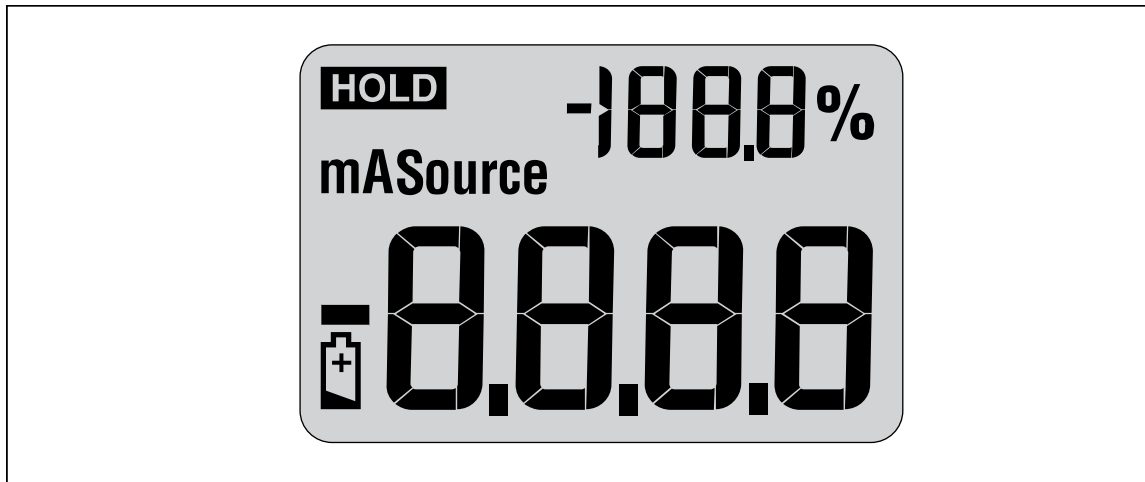



Figure 3. Display Test

fdp1.emf

Display Hold Test

1. Power on the Meter and allow time for the normal operating display to appear.
2. Press **HOLD** and observe that **HOLD** appears on the display. **HOLD** flashes at 3 to 4 second intervals.

Backlight Test

1. Power on the Meter and allow time for the normal operating display to come up.
2. Press  and observe that the backlight comes on.

Spotlight LED Test

1. Power on the Meter and allow time for the normal operating display to come up.
2. Press  and observe that the spotlight LED comes on.

Zero Test

1. Power on the Meter and allow time for the normal operating display to come up.
2. Press **ZERO**. The main display momentarily reads **0.00**, and the percentage scale momentarily reads **-25.0%**.

Accuracy Tests

Accuracy specifications are valid for 1 year after calibration when measured at an operation temperature of 18 °C to 28 °C. Allow the Meter to stabilize at room temperature prior to performing the accuracy tests.

Table 3 lists the required performance test points for verifying Meter accuracy. A zero adjustment must be performed prior to completing each performance test point.

Perform the tests as follows:

1. Connect a single loop of 14 gauge insulated copper wire to the calibrator AUX output terminals.
2. Clamp the Meter jaw around the wire with the jaw arrow pointing toward the calibrator **LO** terminal.
3. Output 0 mA dc from the calibrator.
4. Press **ZERO** on the Meter.
5. Set the calibrator output for the value in Step 1 of Table 3.
6. Compare the Meter displayed reading with the display reading limits in Table 3.
7. Complete steps 2-4 for each calibrator output setting in Table 3.
8. If the Meter fails to meet any of the Display Reading Limits, it requires calibration adjustment, or repair. See Calibration Adjustment or Contacting Fluke.

Table 3. Accuracy Tests

Step	Unit Under Test Function	Calibrator Output Setting	Unit Under Test Display Reading Limits	
			Lower Limit	Upper Limit
1.	mA dc	100 mA dc	98.5	101.5
2.		-100 mA dc	-101.5	-98.5
3.		20 mA dc	19.91	20.09
4.		-20 mA dc	-20.09	-19.91
5.		12 mA dc	11.93	12.07
6.		-12 mA dc	-12.07	-11.93
7.		4 mA dc	3.94	4.06
8.		-4 mA dc	-4.06	-3.94

Calibration Adjustment

Adjustment Subroutines

The Meter features closed-case calibration adjustment using a known reference source. The Meter measures the applied reference source, calculates correction factors, and stores the correction factors in nonvolatile memory.

There are four adjustment subroutines in the Meter adjustment procedure:



- Low Range (± 20 mA)
- High range (± 100 mA)
- Temperature
- Phase







Note

Temperature adjustment should always be performed prior to performing the other adjustment routines. The phase adjustment routine is ONLY required if the unit is repaired or the current clamp is replaced.

Front Panel Operation for Adjustment

Use a small probe to press the calibration button once to enter the Meter's calibration mode. The calibration button is usually covered by the factory calibration seal. A second press of the button saves new calibration constants and exits calibration mode. See Figure 4.

In calibration mode,  is used to select subroutines: low range, high range, temperature, or phase. A short press of  (<1 second) will toggle between low and high range subroutines. A long press (>1 second) will toggle between temperature and phase subroutines.

- Pressing  is valid for all subroutines and normal operation. Pressing  will zero the reading.
- In the low and high range subroutines,  and  are used to adjust the negative and positive gain of the range.
- In the temperature subroutine, only  is valid for adjustment.
- In the phase subroutine,  and  are used to adjust the phase of two sensor-excitation signals by increasing or decreasing a parameter.

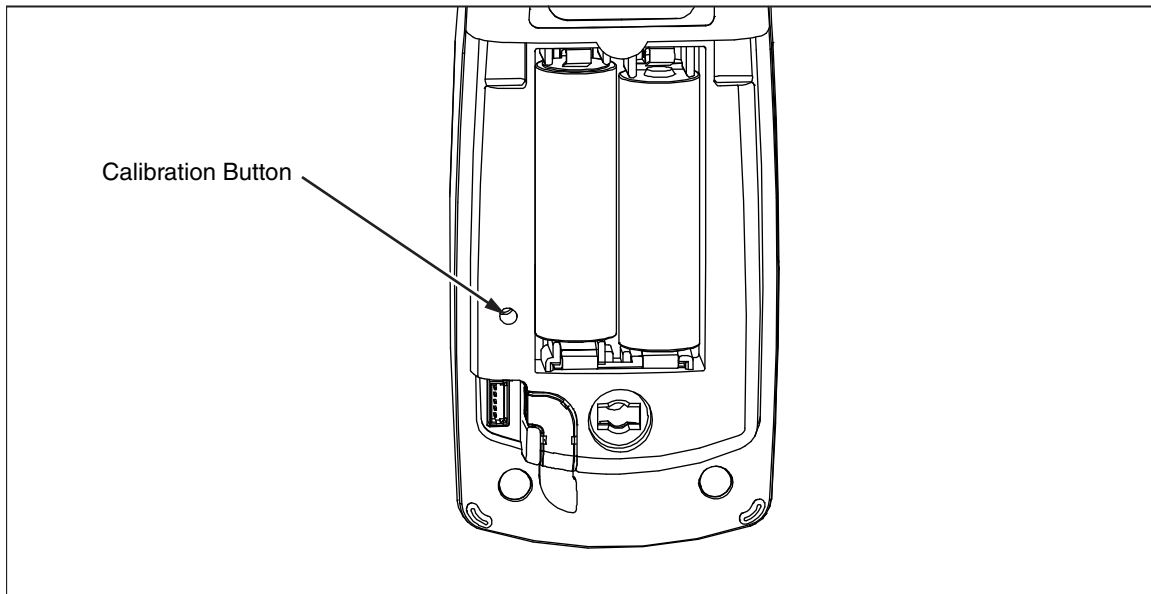

Figure 4. Accessing the Calibration Button

fdp3.emf

Calibration Error Messages

Table 4 lists the calibration error messages that can be shown on the Meter display. The suggested actions to eliminate messages are also listed.

Table 4. Error Messages

Error Message	Cause of Error	Suggested Action
CAL ERR1	The difference between the input level and the zero point is less than the minimal threshold when performing low range and high range adjustments.	Check current loop and ensure correct current is generated.
CAL ERR2	Calibration parameter checksum failure.	Execute all adjustments including temperature and phase.
CAL ERR3	Code checksum failure.	The Meter requires repair.

Calibration Adjustment Procedure

Allow the Meter to stabilize to room temperature before beginning the calibration adjustment.

To prepare for adjustment:



1. Remove the battery door and calibration seal.
2. Clamp the current loop in the current flow direction where required.
3. Turn the meter on and wait at least 10 seconds for warming up.
4. Press the hidden calibration button with a probe to enter calibration mode. See Figure 4.

Note





If the Jaw Assembly has been replaced, do the Phase Adjustment Procedure before you continue.

Temperature Adjustment Procedure





The percentage display should show **t23**, if not:

1. Press  for >1 second until **t23** appears.
2. Wait at least 60 seconds for the internal temperature to balance.
3. Press  to adjust the temperature.

Low Range Adjustment Procedure

1. Clamp the Meter's current clamp around an insulated 18-gauge copper wire with 6-inch diameter. Current flow should be in the direction of the arrow on the current clamp.
2. Press  <1 second until **CAL 20** appears on percentage display.
3. Output 0 μ A dc from the calibrator.
4. Wait at least 15 seconds for the Meter's internal circuits to stabilize.
5. Press  on the Meter to zero the reading.
6. Output 20 mA dc from the calibrator.
7. Wait at least 15 seconds for the Meter's internal circuits to stabilize.
8. Press  on the Meter to adjust the positive gain.
9. Output -20 mA dc from the calibrator.
10. Wait at least 15 seconds for the Meter's internal circuits to stabilize.
11. Press  on the Meter to adjust the negative gain.

High Range Adjustment Procedure

1. Clamp the Meter's current clamp around an insulated 18-gauge, copper wire, with 6-inch diameter. Current flow should be in the direction of the arrow on the current clamp.
2. Press  <1 second until **CAL 100** appears on percentage display.
3. Output 0 μ A dc from the calibrator.
4. Wait at least 15 seconds for the Meter's internal circuits to stabilize.
5. Press  on the Meter to zero the reading.
6. Output 100 mA dc from the calibrator.
7. Wait at least 15 seconds for the Meter's internal circuits to stabilize.
8. Press  on the Meter to adjust the positive gain.
9. Output -100 mA dc from the calibrator.
10. Wait at least 15 seconds for the Meter's internal circuits to stabilize.
11. Press  on the Meter to adjust the negative gain.
12. If the Meter's current clamp has NOT been replaced, press the calibration button to exit the calibration mode.

Note

The following procedure is not required unless the Meter's current clamp has been replaced.

Phase Adjustment Procedure

1. Clamp the Meter's current clamp around an insulated 18-gauge, copper wire, with 6-inch diameter. Current flow should be in the direction of the arrow on the current clamp.
2. Press \odot >1 second until the percentage display indicates the Meter's currently saved 3-digit phase value.
3. Output 0 μ A dc from the calibrator.
4. Press **ZERO** on the Meter to zero the reading.
5. Rotate the Meter's clamp around the current loop conductor and record the minimum and maximum values of the Meter's display reading. See Figure 5.
6. Use \odot and **HOLD**, to adjust the difference between the minimum and maximum value recorded in Step 5, until the reading difference is less than 0.05 mA.
7. Press the hidden calibration button to exit calibration mode. See Figure 4.

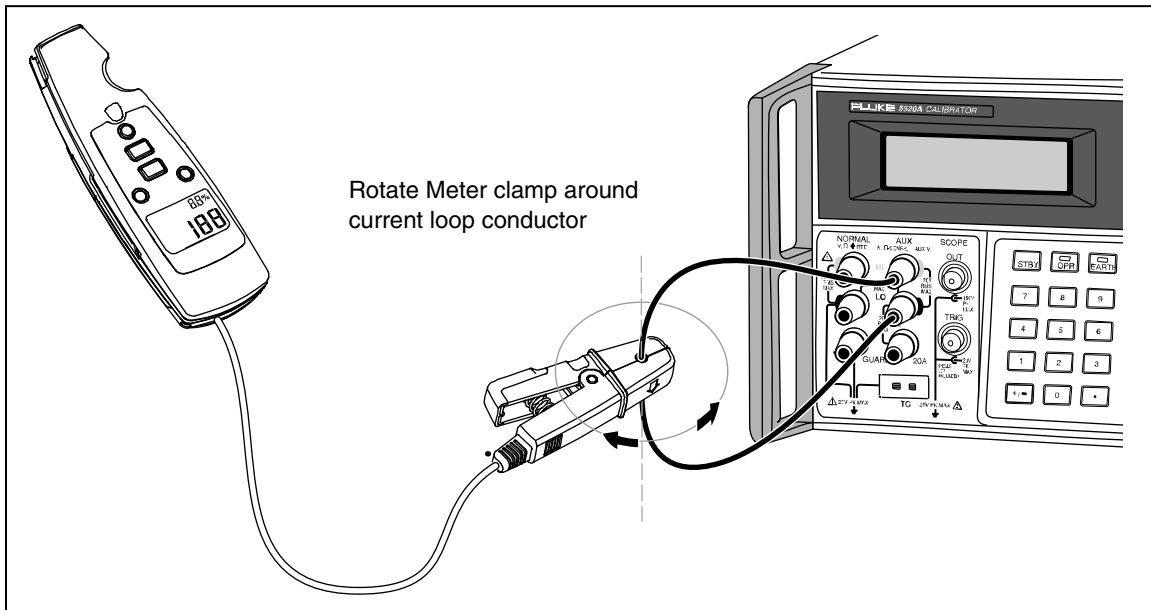

Figure 5. Phase Adjustment

fdp5.emf

User Replaceable Parts

Table 5 and Figure 6 list all user replaceable parts.

Table 5. Replaceable Parts

Item ID	Description	P/N	Qty
①	Decal	2723063	1
②	Case top assembly (does not include decal, order separately)	2720362	1
③	Keypad	2723056	1
④	Jaw assembly (Includes cable) ^[1]	2722971	1
⑤	Screw, m2.2 x 0.8, 8mm, pan, phillips, steel, zinc-black chromate, thread form	1991287	2
⑥	Case, bottom (does not include battery contact, order separately)	2720285	1
⑦	Cable cleat	2720328	1
⑧	Screw, 4-14, 0.375, pan, phillips, steel, zinc-black chromate, thread form	2800097	2
⑨	Battery contact, dual	666435	1
⑩	Screw, m3, 13.5 mm, pan, phillips, steel, zinc-black chromate, thread form	2388412	2
⑪	Battery, primary, mno2-zn, 1.5 v, 2.24 ah, 15 a, lr6, alkaline, aa, 14 x 50 mm, bulk	376756	2
⑫	Battery pad, urethane, adhesive-back, 20.0 mm l, 20.0 mm w, 5.0 mm thk	2687457	1
⑬	Battery door (does not include fastener, order separately)	2720304	1
⑭	Access door fastener	948609	1
⑮	LED housing	2720319	1
-	Soft case, black/yellow	2726174	1
-	<i>771 Instruction Sheet</i>	2567301	1
[1] If the Jaw Assembly has been replaced, complete the <i>Calibration Adjustment Procedure</i> and <i>Phase Adjustment Procedure</i> .			

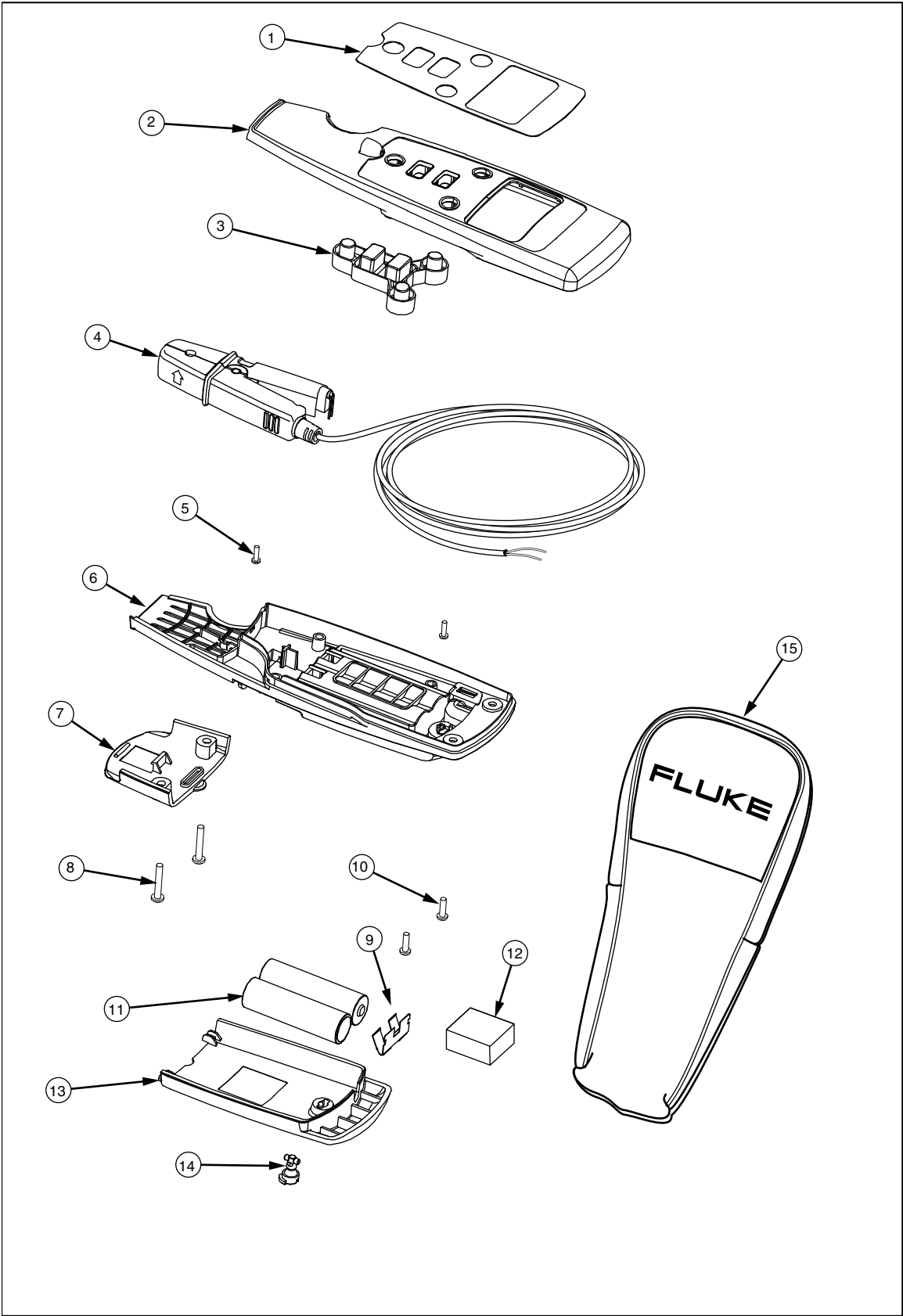

Figure 6. Replaceable Parts

fdp4.emf

